

Classic (LR14)

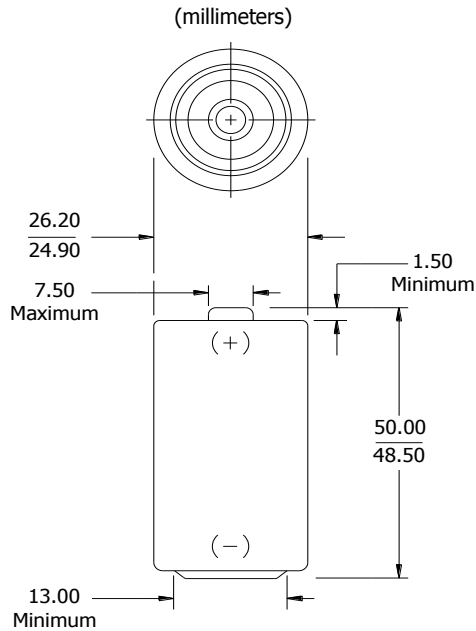

Industry Standard Dimensions



Specifications

Classification:	Alkaline
Chemical System:	Zinc-Manganese Dioxide (Zn/MnO ₂) No added mercury or cadmium
Designation:	IEC-LR14
Nominal Voltage:	1.5 volts
Operating Temp:	-18°C to 55°C
Typical Weight:	66.0 grams
Typical Volume:	27.0 cubic centimeters
Jacket:	Plastic Label
Shelf Life:	7 years at 21°C
Terminal:	Flat Contact

Performance Comparison

Classic vs. Typical Carbon Zinc (D) at 21°C

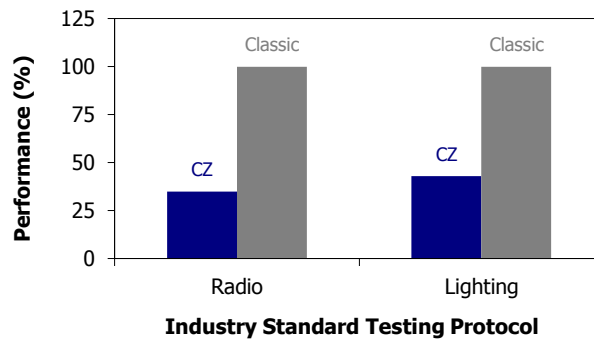

Device Selection Guide:

Portable Stereo



Toy



Lighting



Radio



Battery Selection Indicator

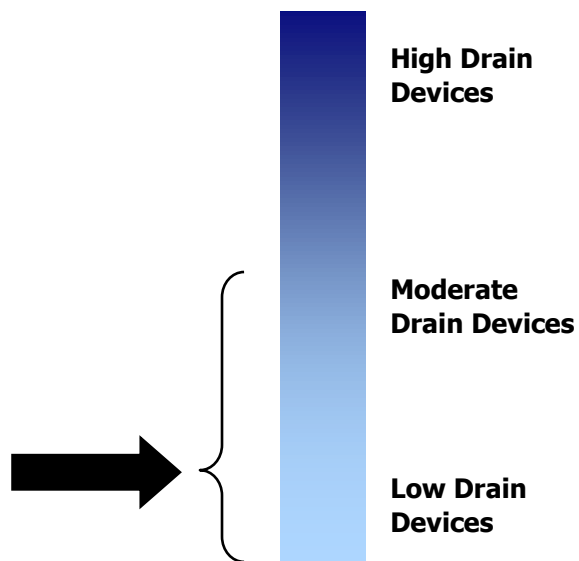

Important Notice

This data sheet contains typical information specific to products manufactured at the time of its publication.
©Energizer Holdings, Inc. - Contents herein do not constitute a warranty.